

# IWAKO BLOCKS®

## 組立説明書 Instructions

# ブルドーザー

### ★用意するパーツ

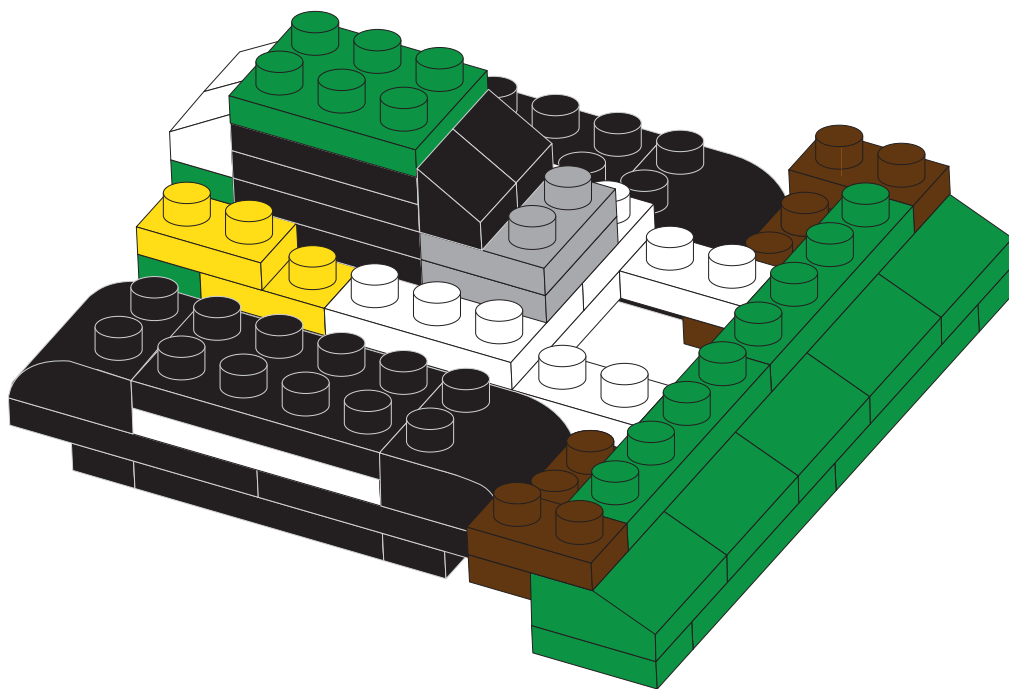
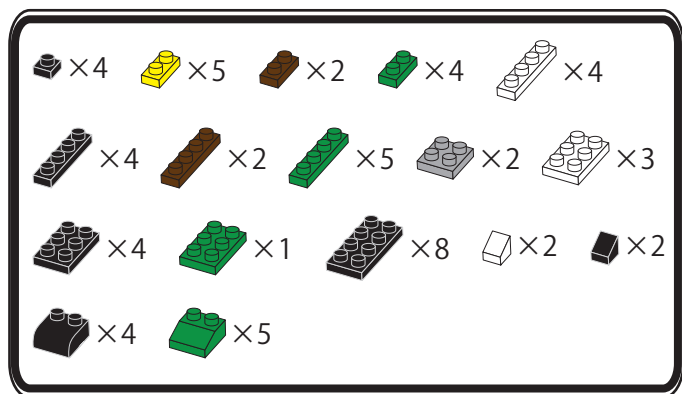

1

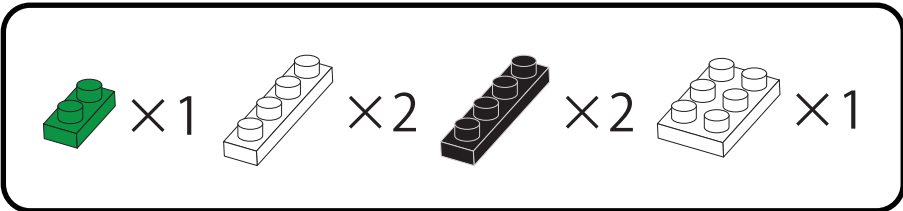
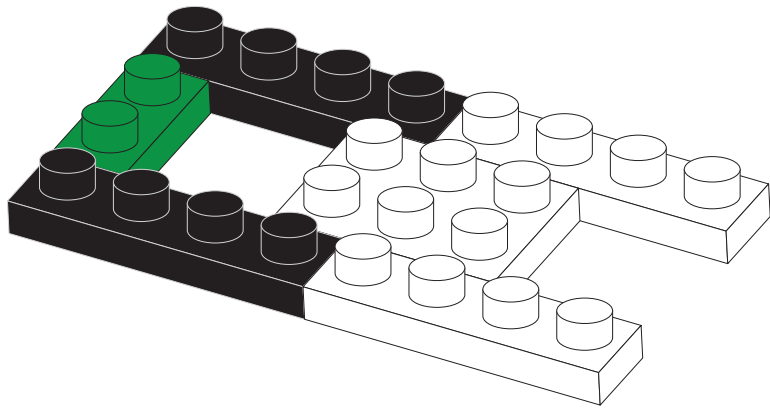

2

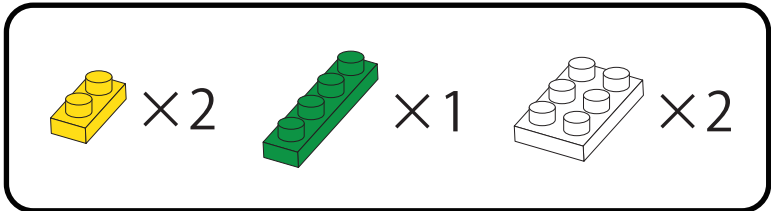
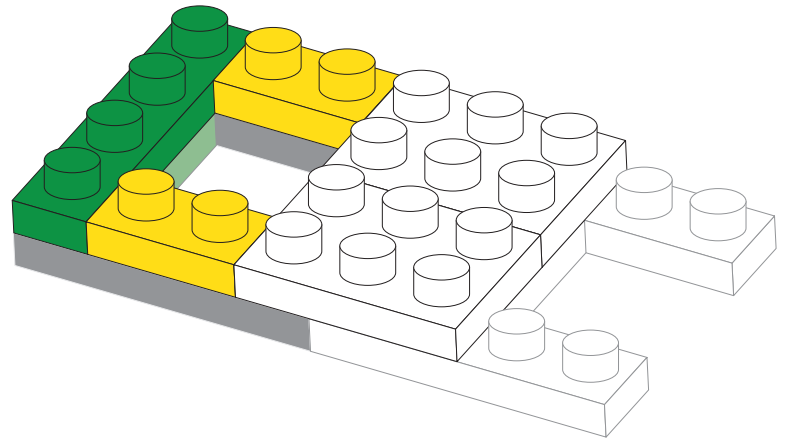

3

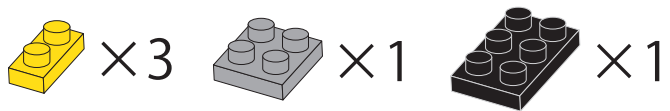
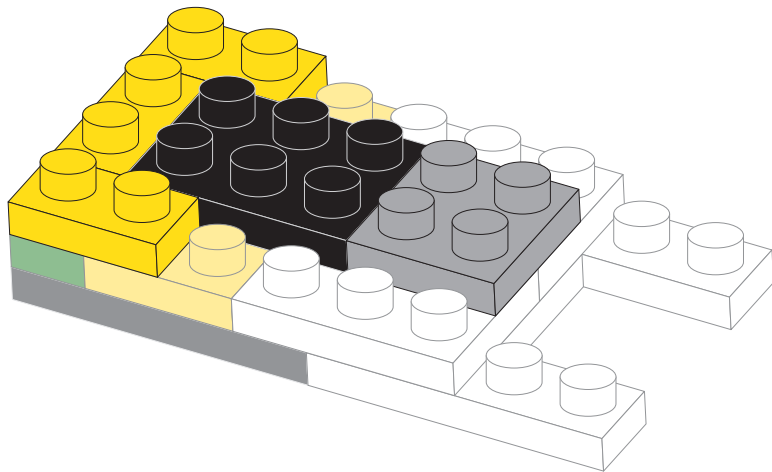

4

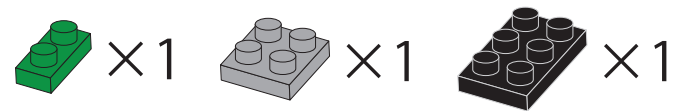
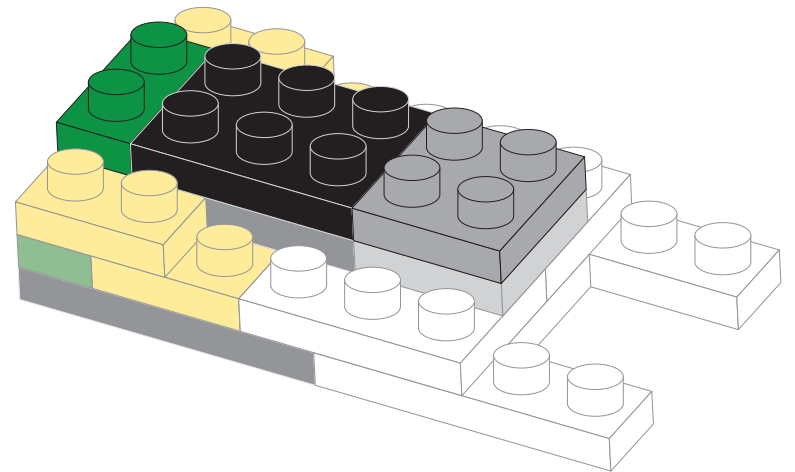

5

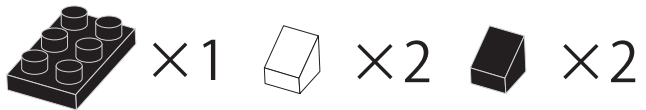
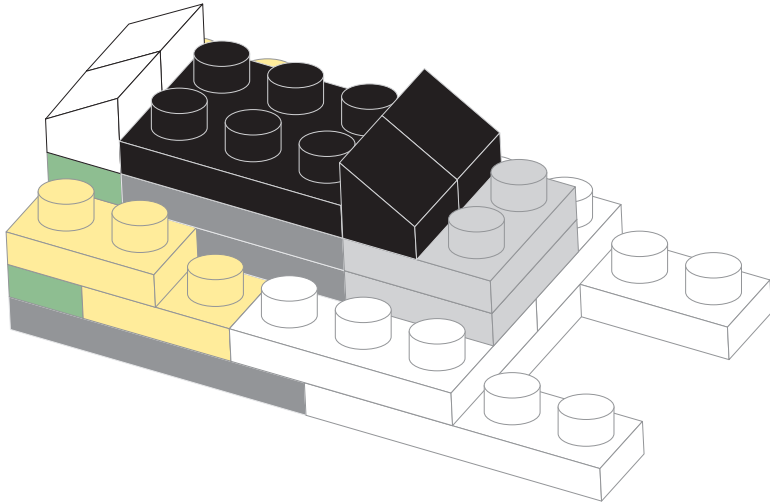

6

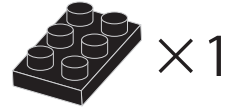
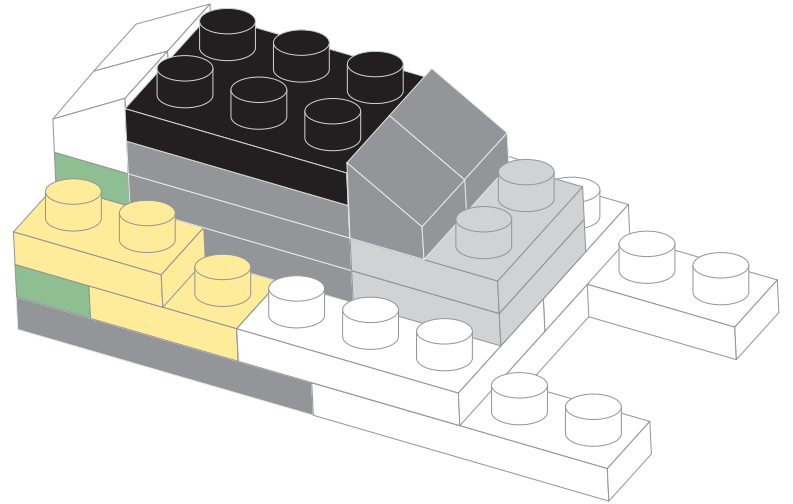

7

A

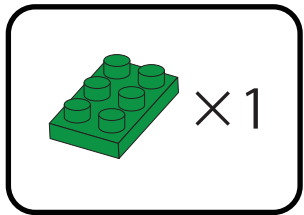
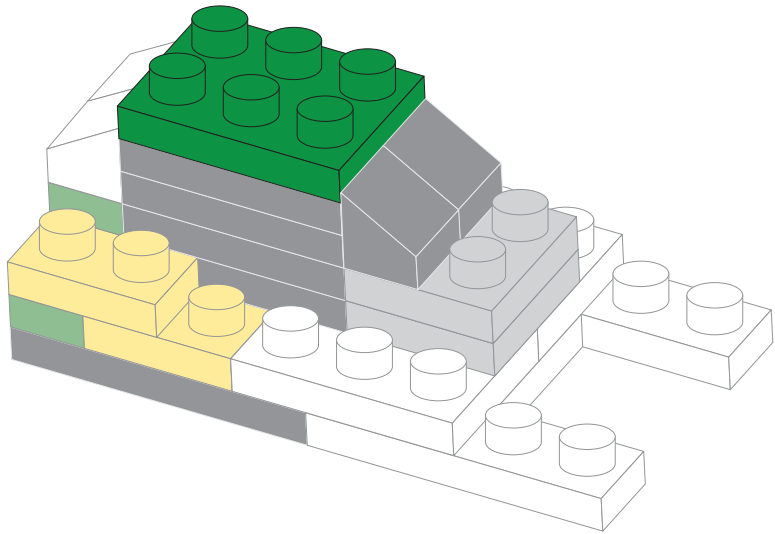

8

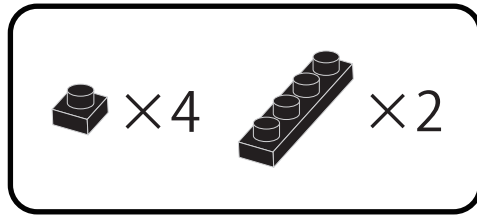
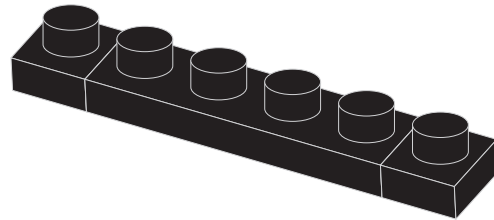
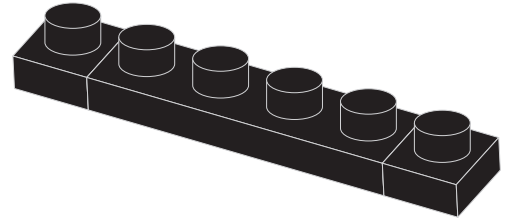

9

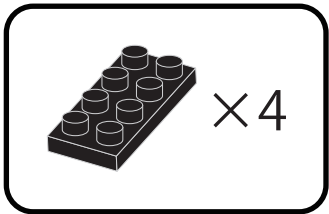
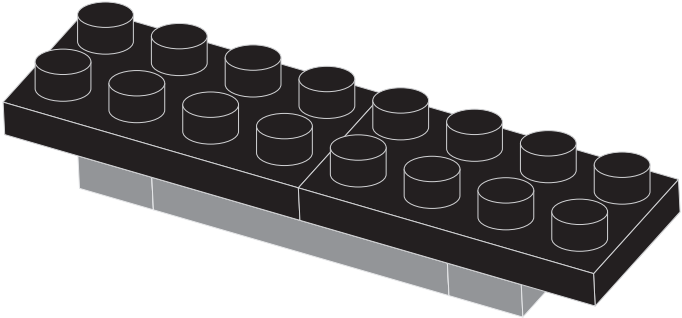
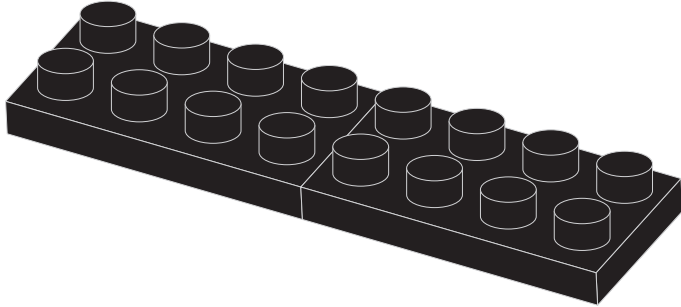

10

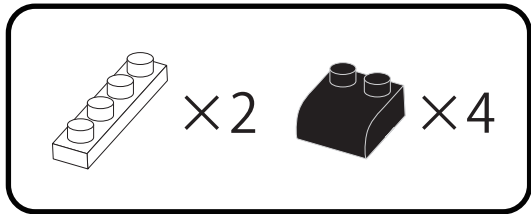
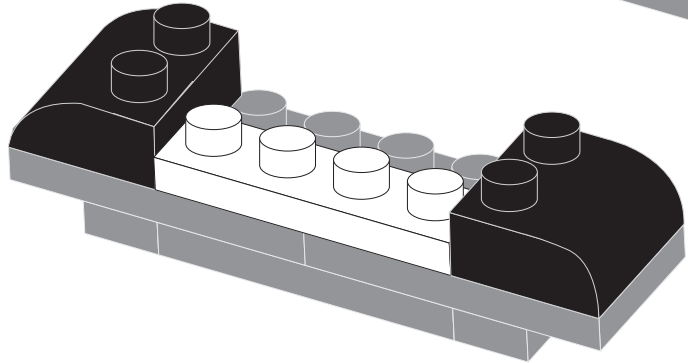
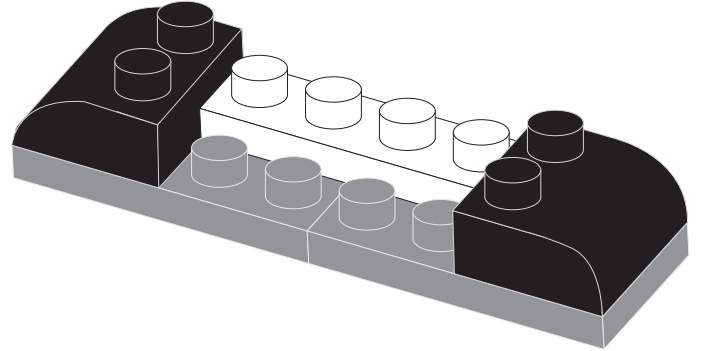

11

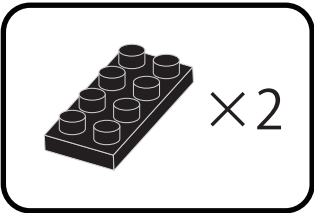
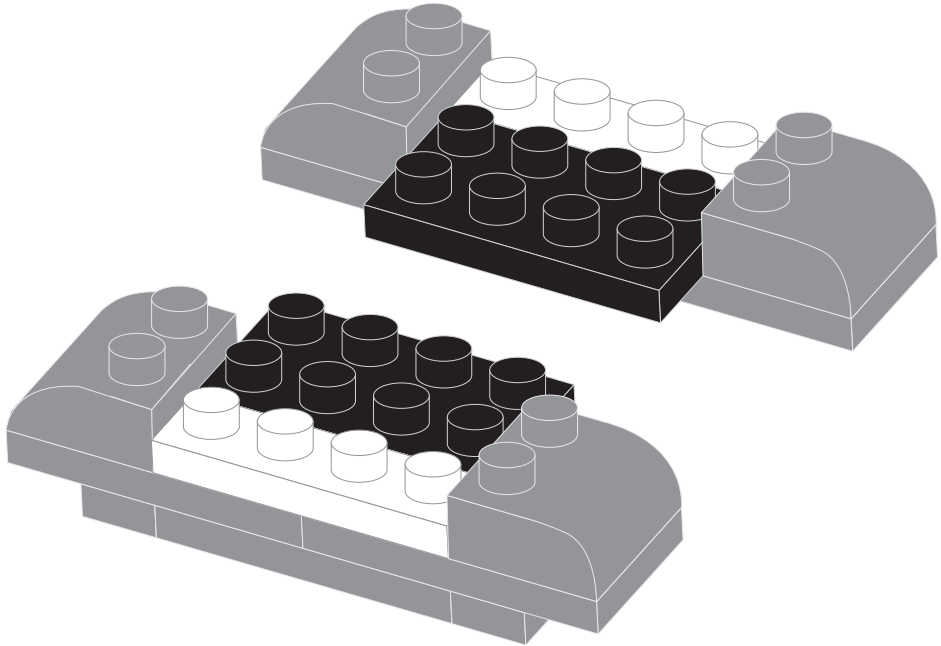

12

B

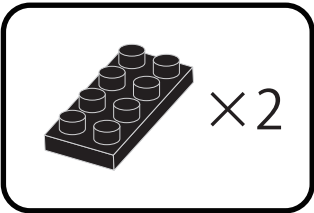
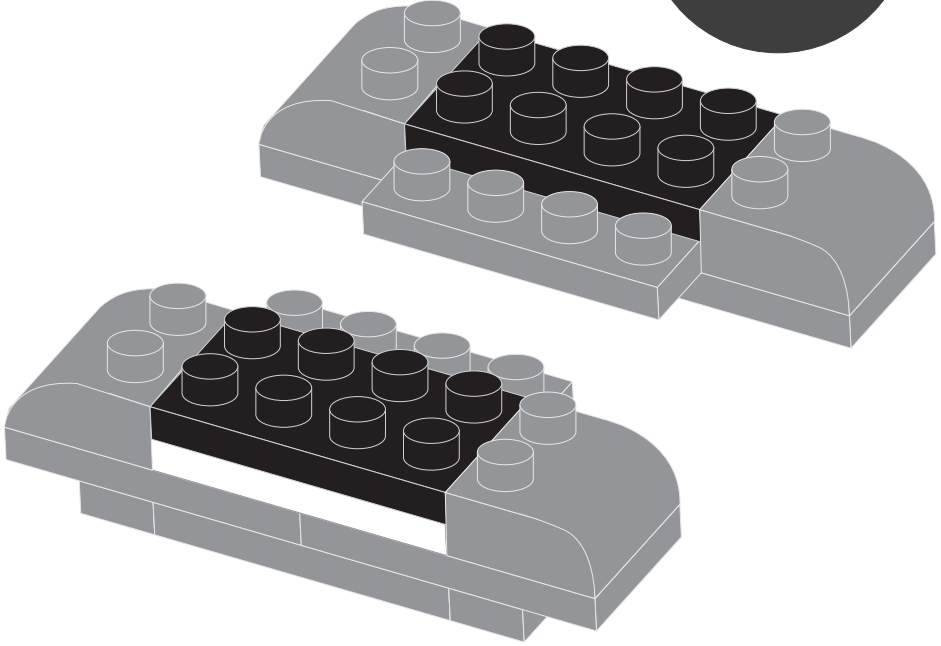

13

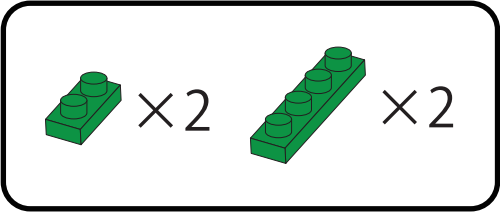
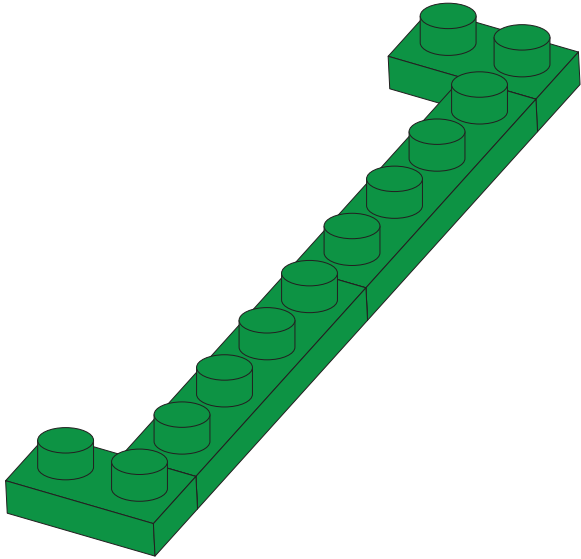

14

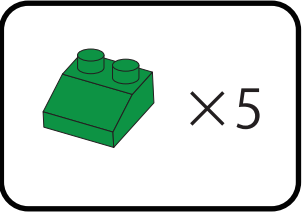
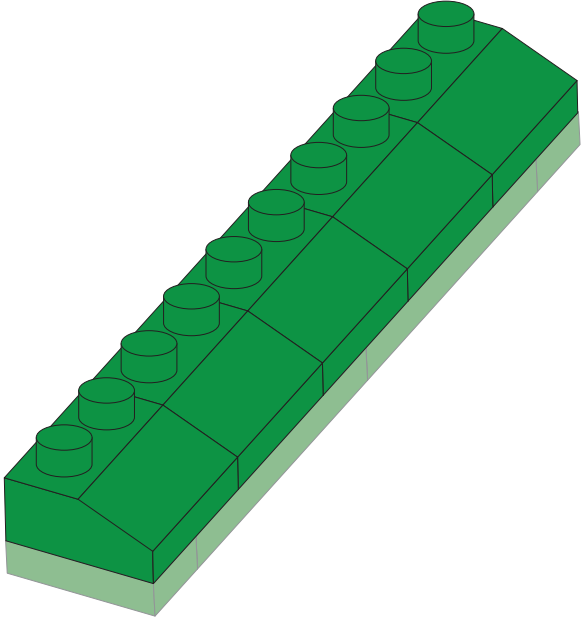



15

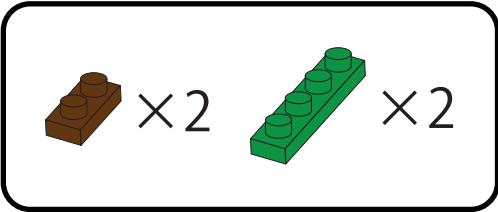
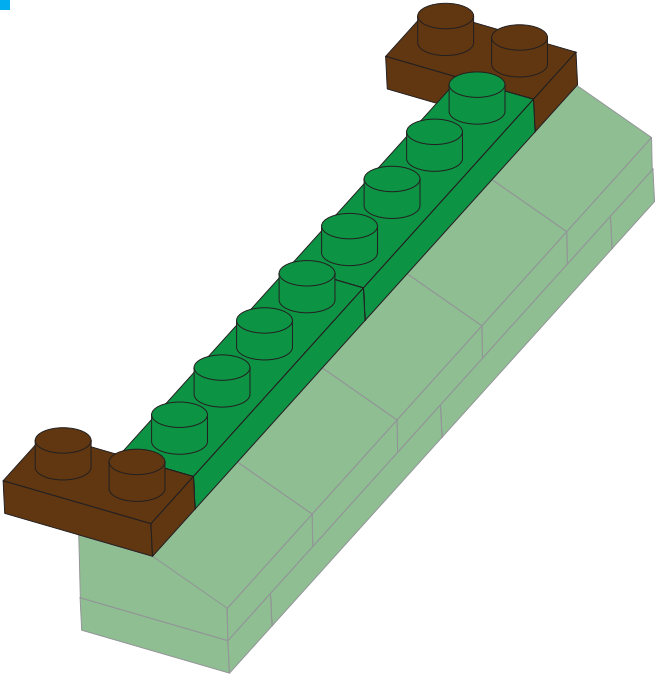

16

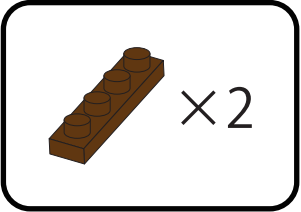
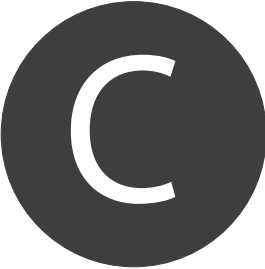
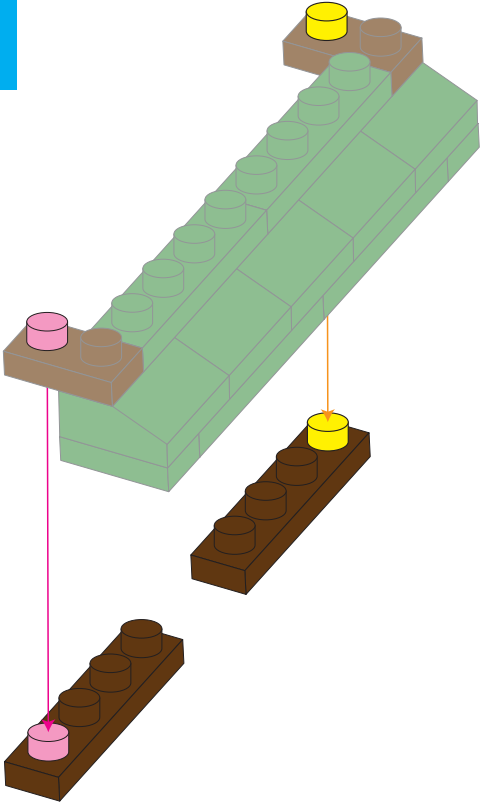

17

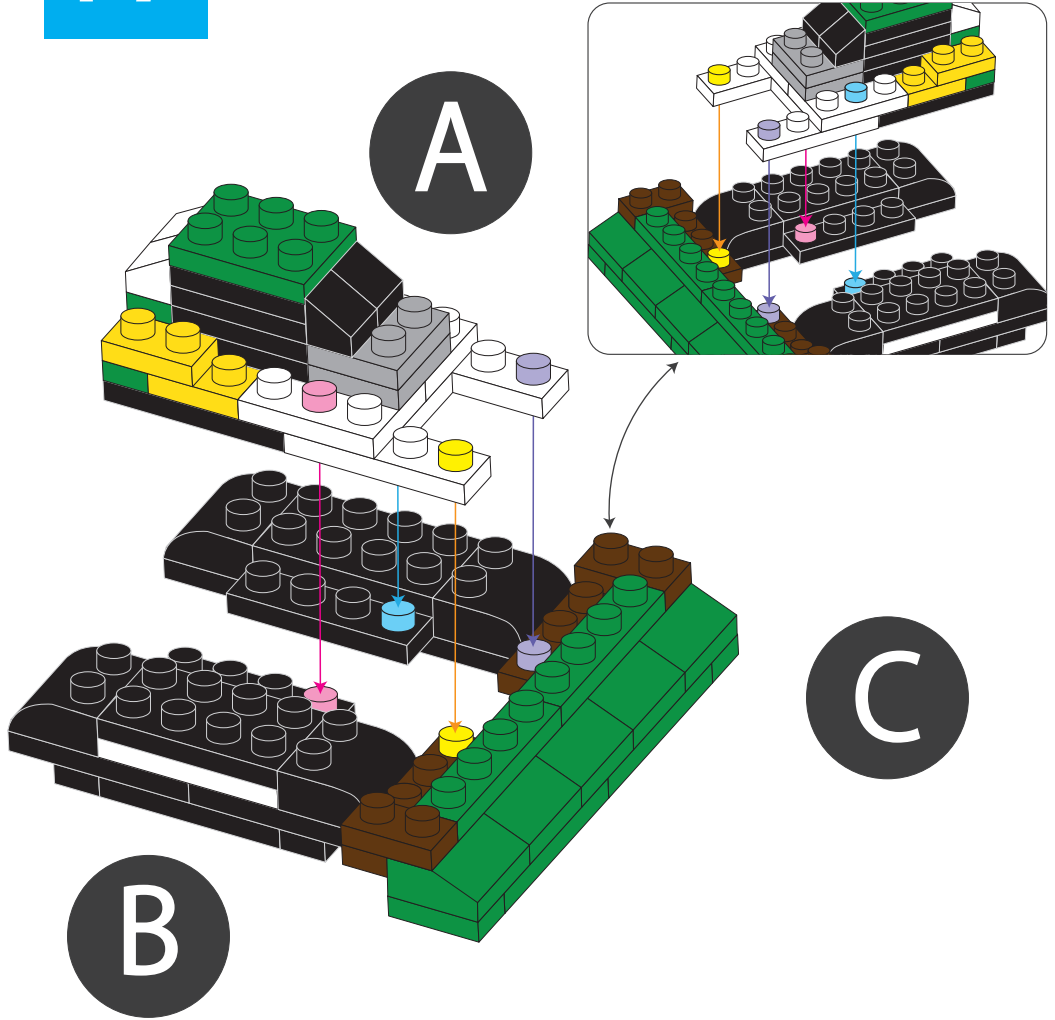

18

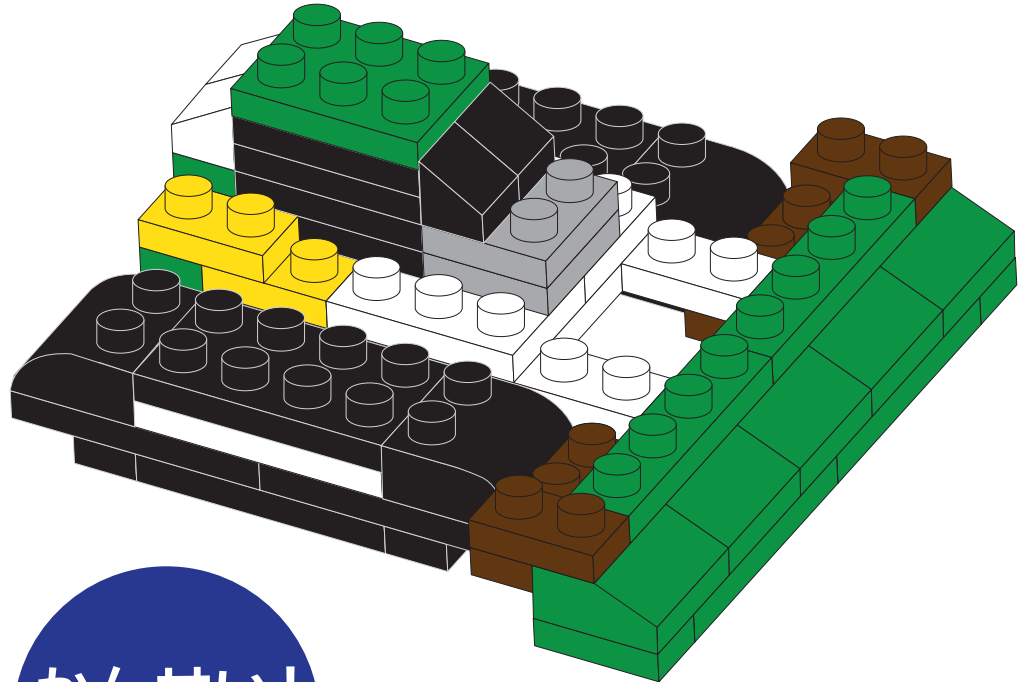

かんせい!  
Finished!